

Maintenance Manual for “Piggott” Small Wind Turbines

Version 3.2

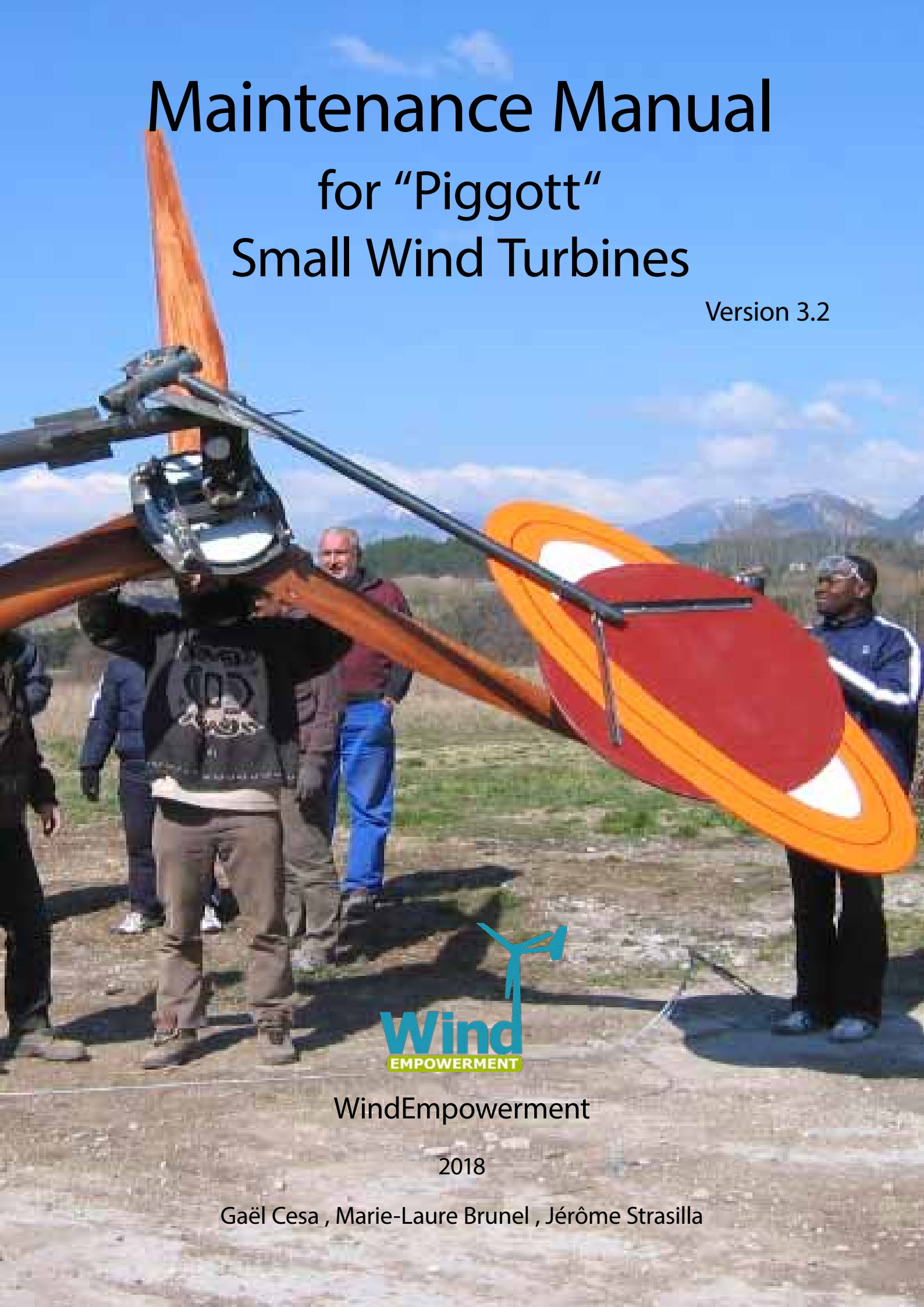

WindEmpowerment

2018

Gaël Cesa , Marie-Laure Brunel , Jérôme Strasilla

Maintenance Manual

for “Piggott” Small Wind Turbines

Version 3.2.1



Content & Layout:

Maintenance Working Group:
Marie-Laure Brunel, Gaël Cesa, Jérôme Strasilla

Publishing date:

March 2018

Acknowledgement:

Hugh Piggott, Jon Summanik-Leary, Jay Hudnall, Valéry Benton,
Christophe Glaziou

In collaboration with:



RESEAU TRIPALIUM

Funded by:



Content

Content.....	page	3
1 Preface & introduction.....	page	4
2 Safety & precautions.....	page	5
3 Environmental factors.....	page	6
4 Tool list.....	page	9
5 Lowering and raising the turbine.....	page	12
5.1 Securing the area and the WT.....	page	12
5.2 Lowering the WT.....	page	15
5.3 Disassembling the WT.....	page	17
5.4 Reassembling the WT.....	page	18
5.5 Raising the tower.....	page	19
6 Maintaining your wind turbine system.....	page	21
6.1 Blades.....	page	21
6.2 Alternator & frame.....	page	23
6.3 Tower & foundation.....	page	29
6.4 Electrical system.....	page	31
7 Service frequency.....	page	36
8 Check list.....	page	37
9 Troubleshooting.....	page	40
10 Logbook.....	page	43
Appendix.....	page	45

1 Preface & introduction

Preface

The present document is a maintenance manual for “Piggott” based designed small wind turbines (SWT), developed by WindEmpowerment (WE) association (<http://www.windempowerment.org>). Founded in Senegal in 2011, WindEmpowerment is involved in the development of locally manufactured small wind turbines for sustainable rural electrification around the world.

Wind Empowerment’s Maintenance Working Group (WG) was formed in Athens during the 2nd global conference, with the following group vision:

“To mutually empower people to keep their turbines running.”

Tripalium (French network for *Piggott* wind turbines: <http://www.tripalium.org>) produced the first two versions of a maintenance manual that has been translated into an english version for WindEmpowerment. The 3rd version is the result of 6 months of teamwork. The objective is to increase users autonomy for producing their own electricity by being able to operate and maintain their wind turbines. This manual is available as a free download at the WE and WE members website. However donations are suitable to support a future edition of this maintenance manual. All SWT operators are invited to download and print the manual and keep it close to their turbine.

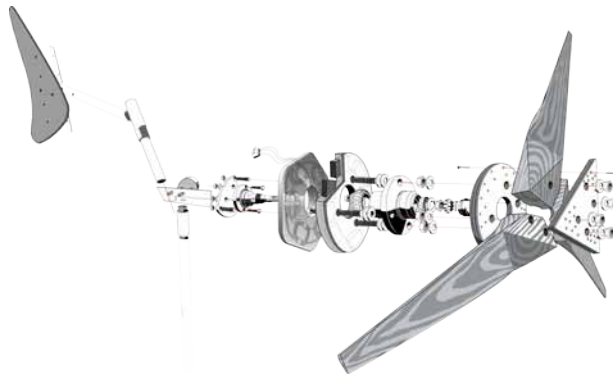

Introduction

Wind turbines are a fascinating way to produce electricity and increase energy autonomy. On a good site you can produce most of your needs with the fruit of your endeavours.

Many wind turbines inspired and based on a concept developed by Hugh Piggott have been manufactured all around the world. Whilst most of the turbines built according to these specifications performed well initially, many broke down after some time due to a lack of appropriate maintenance. This is a particular problem for WE-members who implement electrification projects in remote areas of developing countries, where local technical capacity to perform repairs is low and travel time to reach installation sites are particularly long.

This 3rd maintenance manual edition includes preventative and corrective maintenance according to common issues based on our experience and the WE-members feedback from around the world.

It takes into account environmental factors influencing maintenance needs, a list of the tools that you need to perform the maintenance steps, more detailed maintenance procedures, troubleshooting, a check list and finally a crash page with stories of what went wrong at different SWT installation sites.

Nevertheless, other events not listed can occur. For this reason this document is meant to be updated in the future. A database will be available online to monitor SWT maintenance actions but also failures or breakdowns that occurred, so we encourage you to give us your feedback at windempowerment.group@gmail.com to help us to improve future editions. This manual is mainly focused on Piggott SWT design concept with guy wired tower, for off-grid and grid-tied systems. However, it can also be useful for commercially manufactured turbines.

We hope this work will help you to operate and maintain your turbine so it can reach it’s full potential.

2 Safety & precautions

Safety should be your primary concern during all maintenance actions performed on your small wind installation and particularly when raising and lowering the tower. Be attentive for risks that may arise from both electrical and mechanical components.

Unlike most of maintenance manuals for manufactured goods, we strongly encourage you to take apart your turbine.

Check the weather forecast before planning a maintenance service.

Before any maintenance action it is absolutely essential to:

Stop the wind turbine switchin ON the short-circuit brake (figure 1).

Mechanical hazards



Disassembling the permanent magnet generator:

The rotors have very powerful magnets, therefore it is dangerous to have metal objects or tools close to the rotors. When the two rotors are removed, they must be stored at the appropriate distance from each other, at least 1.5 m.

Be careful when you dismount the **blades** to store them in a safe place to avoid any damage.

Electrical hazards

Power cables



Risk of electroshock from touching the live wires for 48V and grid-tied systems (400V), especially if you disconnect a cable and as a consequence your turbine is spinning freely.

Batteries



- A short circuit in the wires connected to the batteries can cause a burning or an explosion.
- Charging a lead-acid battery emits hydrogen, which is highly explosive.
Make sure that the area where the battery is located is well ventilated.
- Watch out for sparks, flames and other sources of ignition!

Magnets



If you have a pacemaker or other medical devices, stay away!

The permanent magnet generators have a particularly **powerful magnetic field**.

Safety gear

We recommend you to wear safety equipment like gloves, safety shoes and a safety helmet.

But remember that the best safety is to work intelligently and making sure the people around you are equally behaving in a responsible manner.



Fig. 1: Brake switch



3 Environmental factors

The following table provides an overview about factors that can significantly influence the life span of a SWT.

- The worst enemies of SWT are:
- Strong winds & turbulent wind conditions
 - Water
 - Salt
 - Sand/erosion
 - Lack of maintenance

If a wind turbine is running below one or more of these factors, it will require more frequent preventative maintenance.

Tab. 1: Environmental factors influencing the life span of a SWT

Factors	Risks	Countermeasures	Main sensitive parts
<p>Lightning</p> 	<p>Destruction of the system (turbine and electronics)</p> <p>In grid-tied system: Risk to burn the inverter and electronics from a strike on the grid</p>	<p>All the guy wires should be connected together with the tower to a ground rod (figure 2) or at least connected to the ground next to each anchor.</p> <p>The electrical system should also be connected to the same ground rod via a ground cable to the tower.</p> <p>Be sure there is a lightning arrester between the tower and the electronics.</p> <p>On a grid-tied connection, be sure there is a lightning arrester between the grid and the inverter.</p>	<ul style="list-style-type: none"> • electronics • anchors
<p>Saline air</p> 	<p>Corrosion of magnets (comes from the rust inside the resin), guy wires and all metallic parts (tower, frame, etc.)</p> <p>Wear of components made of plywood (especially if poor quality plywood)</p>	<p>Protect exposed metal materials and rotors of the WT with a painting against corrosion.</p> <p>Change rusted fastenings and guy wires by stainless ones. If you have galvanized ones, protect them with old car oil or other kind of grease.</p> <p>If the magnets are corroded, build new rotors and paint or galvanise the disks, and use epoxy resin. Use also epoxy coating magnets</p> <p>Use high quality plywood or change by metal parts.</p>	<ul style="list-style-type: none"> • neodymium magnets • guy wires • other metallic part (frame, tail, tower) • plywood parts
<p>Hail</p> 	<p>Blades affected by erosion</p> <p>Tail damaged</p> <p>The paint on metal parts can be removed</p>	<p>Fix holes and eroded parts with epoxy resin and protect the blades with paint or polyurethane varnish.</p> <p>Protect the plywood tail with resin or polyurethane varnish.</p>	<ul style="list-style-type: none"> • blades • tail

Tab. 1: Environmental factors influencing the life span of a SWT



Factors	Risks	Countermeasures	Main sensitive parts
Sandy environment 	Abrasive effect, strong wear on the leading edge of the blades, and on the whole system	Paint your blades with layers of different colours. If a layer of colour gets exposed by erosion, refurbish the blade surface with a new layer. Put some tape on the leading edge to protect the blades, or protect them with epoxy resin. Remove the sand at the tower base regularly (figure 3). Protect chains by pouring them into concrete (figure 4). Protect guy wires and fittings with oil or grease (can also be old car oil)	<ul style="list-style-type: none"> • blades • base of tower • anchors • metal parts
Hot-dry climates 	Overheating of electrical components (High temperatures can reduce the battery life by more than 75%)	Don't paint the stator, it will help the cooling of the coils by ambient air. Make sure all electrical components are ventilated and not enclosed. Make sure batteries are air-cooled: surelevate them on a wooden palette, try air-conditioning, and make a good insulation of the battery room.	<ul style="list-style-type: none"> • electric and electronic components
Cold climates 	Icing leads to cracks and imbalanced blades Infiltration of snow and ice into the junction boxes and resin leads to cracks	Check the waterproofness of the junction boxes and the wire connections inside, change them if necessary. Check and repair holes and cracks in the blades and resin components.	<ul style="list-style-type: none"> • blades • electrical connections



Fig. 2: Ground connection of the tower and electronics

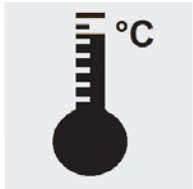

Fig 3: Sand at the tower base

Tab. 1: Environmental factors influencing the life span of a SWT





Factors	Risks	Countermeasures	Main sensitive parts
Storms 	<p>Strong vibrations on the whole system might break the blades and/or tail</p>	<p>Lower the turbine if a storm is predicted or inspect your turbine after the storm.</p>  <p>We recommend to let the turbine running because when it is stopped, a high wind speed can be stronger than the BEMF with a risk to burn the coils and the blades keep on-wind, which means stronger mechanical forces on the blade area, with higher risk of failure.</p>	<ul style="list-style-type: none"> turbine tower
Turbulence 	<p>Electrical cable at the bottom of the tower twists more frequently</p> <p>Vibrations on the whole turbine and tower may increase the risk of failures</p> <p>Furling system wear</p>	<p>Use a higher mast to rise the wind turbine above the surrounding vegetation and obstacles.</p> <p>Untwist the cable at the bottom of the tower more frequently.</p> <p>Check the blade balancing more often.</p> <p>Strengthen the tail vane.</p>	<ul style="list-style-type: none"> electrical cable turbine tower
Rain 	<p>Infiltration of water in blades, plywood, rotors and junction boxes</p> <p>Corrosion</p>	<p>Check and repair holes and cracks in the blades and resin parts.</p> <p>Be sure the junction boxes are still waterproof or replace them.</p> <p>Protect the plywood tail with resin or polyurethane varnish.</p>	<ul style="list-style-type: none"> electrical components rotor stator blades



Fig. 4: Guy wires protected by oil

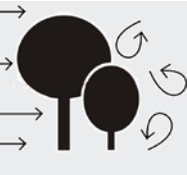

Fig. 5: Chain poured into concrete

4 Tool list

If your installation is particular (e.g., if the gin pole is disassembled) consider that you may need more tools and some specific parts.

To lower and raise the tower:

Tab. 2: Tool list to lower and raise the tower

Designation	Qty.	Characteristics	
Pulling wire grip hoist and its cable (and pulley for 24m tower)	1	Up to 2m40 & 18m height: 800kg; 20m cable	From 3m; 18m or 24m height: 1,6t; 25m cable
Spanner	2	Large size (22, 24 or 26...) for tower & gin pole	
Cords	1 or 2	3 x gin pole length in total	
Multi-use pliers	1	Large one	
Shackle	3	Equal or greater to the grip hoist maximum pulling strength	
Lubricant	1	WD40 type	
Tripod or sawhorse	1	High enough to avoid blades touching the ground	

To disassemble, check and repair the turbine:

Tab. 3: Tool list to dismount, check and repair the turbine

Designation	Qty.	Characteristics	Tower	Blades	Alternator	Frame/tail	Elec.
Hammer/mallet	1			X			
Spanners	2 of each	Current sizes for WT: 17, 19, 22			X		
Adjustable wrench	1	Large enough for the bearing nut			X		
Small spanners	2 of each	8 to 13	X			X	X
Screwdrivers	2	1 small (to unscrew the terminal blocks) and 1 normal bit					X
Cross (or Phillips) screwdrivers	2	2 different sizes: 1 small and 1 bigger					X
Cutting clamp	1				X		X
Universal pliers	1				X		X
Jacking screws	3				X		
Cordless drill/bit with cross bit	1			X			
Rags	2		X	X	X	X	
Files	1					X	
Multimeter	1						X

Consumables and spare parts:

Tab. 4: List of consumables and spare parts

Designation	Qty.	Characteristics
Sand paper	1	Different grits
Silicone	1	
Wood glue	1	
Linseed oil	1	Optional
Epoxy resin & hardener	1	
Polyurethan varnish	1	In 2 components
Epoxy glue	1	In 2 components
Brushes	3	
Anti-corrosive paint	2	
White spirit	1	
Grease	1	
Grease remover	1	Like window cleaner
Threadlock	1	Optional
Electrical tape	1	
Iron wire	1 or 2m	
Packs of plastic cable ties	2	Small ones and large ones
Nuts	6 of each	M6, M8, M10, M12 and/or M14; stainless steel
Bolts	6 of each	
Washers	6 of each	D6, D8, D10, D12 and/or D14; normal and large ones; stainless steel
Wooden screws	20	M5; zinc or stainless steel
Cable clamps	20	6 or 8 (according to guy wire diameter); galva steel
Thimbles	10	
Shackles	4 of each	8 and 12 diameter
Turnbuckles	2	For 6 or 8mm diameter guy wires
Junction box	1	
Cables	1m of each	Mono strand, 2.5mm ² , 4mm ² , 6mm ² , 10mm ²
Electrical terminal blocks	6 of each	10 and 16mm ²
Crimp lugs	10 of each	Different sizes
Fuses	2	Check characteristics of the system (maximum current)
Set of rolling bearings	1	



Fig. 6: Usual tools



Fig. 7: Consumables

Additional materials:

In case an important reparation (corrective maintenance) needs to be performed on a SWT-system, find out the state of the damages from the operator as precise as possible before going on site, especially on far and remote locations. Take more tools, materials and more spare parts than the ones listed above, and other spare parts, in case of unforeseen damages.

Tools:

- Grinder machine with sand, cut and flap disks
- Generator and oil
- Drill
- Portable welding machine

Spare parts:

Tab. 5: Additional spare parts

Spare parts	Qty.	Characteristics
A set of 3-phase cable	15-25m	According to tower height, check for initial cable diameter
Brake switch		Same characteristics as the original
Rectifier and heat sink		
Metal parts (flat, angle, pipe)		For blade balancing and for frame/tail/tower
Removable balancing tower		For balancing the blades
Threaded rods	2m	M12 or M14, stainless
A set of guy wires	D6, 50m	Galvanised or stainless
Marine plywood triangle, disk, tail		Check for original thickness

5 Lowering and raising the turbine

Usually the tower of a Piggott wind turbine is made of pipes assembled and kept in vertical position with guy wires. Turbine lowering and raising operations are done with a gin pole and a grip hoist. It can be dangerous don't take unnecessary risks. The main risk is the **tower falling down with the turbine**. In worst case, **a person can be seriously injured**. This can happen in case of:

- One or several guy wires break on the same side.
- A grip hoist cable breaks or the cable is released abnormally (problem with the break lever of the grip hoist)
- Strong wind

To prevent these risks, follow the precaution safety operations.

For the electrical inspection it is important that your turbine is operating. Therefore go to section 6.4 to see the steps that need to be done before lowering the turbine.

A team of at least 2 experienced people is required but 4 people make the work a lot easier.

5.1 Secure the area and the whole system

Safety warnings:



A helmet is compulsory for people working in the perimeter of a seize as follows: Circle radius equal to tower height (people without helmet should be kept outside the working area that is displayed in figure 9).

Only 1 person is leading all operations and explains the risks and precautions to others

Nobody is allowed to **stand in** or to **pass the lowering tower direction** during all the operation (see the red dangerous area in figure 9)!

Be sure that the wind speed is **below 7m/s**

After checking your system in **Operation** (see section 6), **Switch ON the circuit brake** (see figure 8).

Check and **remove any obstacles** that can **disturb** the operation, especially at the base, anchors, and in the lowering direction area. Make sure the electric cable will not be pinched during the process.

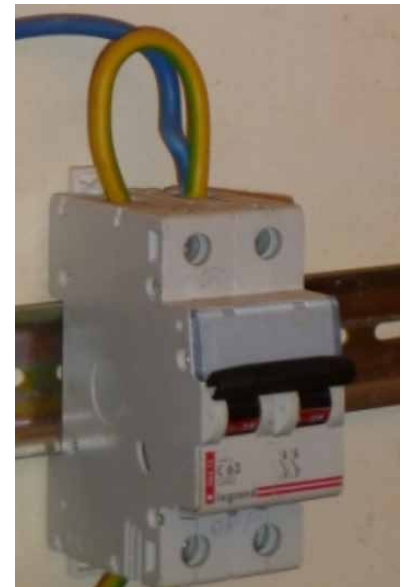

Fig. 8: Brake switch

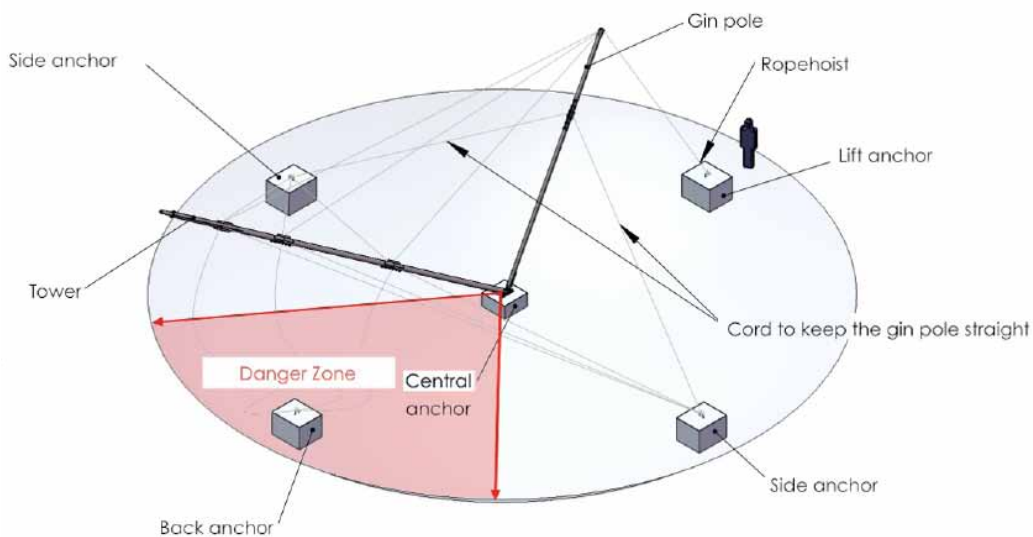

Fig. 9: Working area and safety zone

Installing the pulling grip hoist

Note: it's assumed that the gin pole is already fastened to the tower. If this is not the case, you will need to install the gin pole between the foot of the tower and the lift anchor. Start by attaching the grip hoist to the head of the gin pole and the lift anchor. One by one (or together if they are attached at the same part), detach the guy wires from the lift anchor to the head of the gin pole. The tower should always be attached to prevent it falling over.



Fig. 10: Wire pulling grip hoist

Install the grip hoist properly:

Release the grip hoist brake ('Brake', figure 10)

- Pulling Lever** : To raise the tower
- Release Lever** : To lower the tower
- Brake** : ON to activate the hoist
OFF as on figure 10



Fig. 11: Extremity of the gin pole with the grip hoist

Insert the full wire from the extremity without hook into the hole, going out from the pin side.

Fasten the grip hoist to the lift anchor with a strong shackle and fasten the grip hoist hook to the gin pole extremity plate with another shackle (figure 11).

Engage the grip hoist brake (see figure 10).

Fasten 2 cords between the gin pole and each side anchor (see figure 11).

Fasten a cord or a strap on the guy wire in the lowering direction (used to pull the guy wire helping to lower the tower at the beginning of the operation):



Fig. 12: Strap on the top guy wire (lowering direction)

Unscrew the turnbuckle that connects the gin pole with the anchor (it can be a piece of chain or guy wire).

Remove the safety wire that locks the turnbuckles:

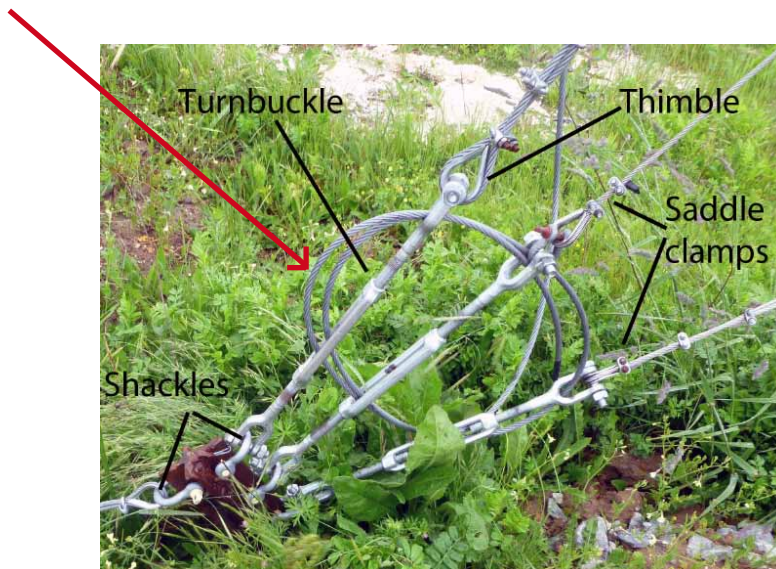

Fig. 13: Guy wire fastenings and safety wire

Put a support like a saw horse or a shipping crate in the lowering direction, where the top of the tower is expected to touch the ground. Place a wooden palette close-by in order to support the tail (see figure 16) so that the blades are facing the sky.

5.2 Lower the wind turbine

Manpower (4 people if possible):

- One person operating the grip hoist, checking the verticality of the tower and the gin pole, aware of any abnormal thing, and being in command of the team
- One person per side anchor maintaining cords and controlling wire tension
- One person at the back anchor, away from the lowering direction, pulling the guy wire

Start activating the front lever (see figure 10) to release the gin pole while pulling on the back guy wire with the strap or cord to help lowering the tower, **away from the tower !** as on figure 14 :

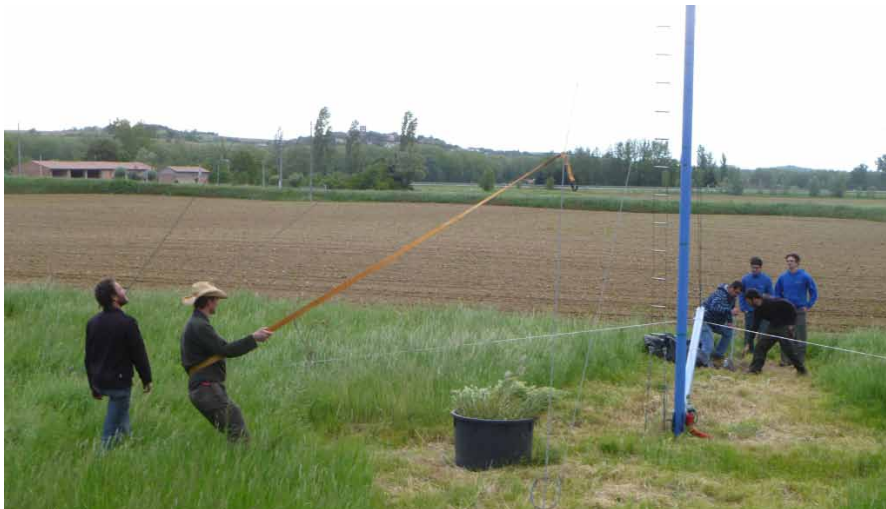

Fig. 14: Pulling top guy wire strap

Continue to lower the tower and check that the tower and the gin pole are vertical at any time, otherwise warn the lateral anchor operator to adjust the cord tension. If the tower is oscillating, reduce the rythm of lowering.



Fig. 15: Lowering the tower



In case of a problem **you can stop activating the grip hoist** and even raise back the tower back at any time if necessary changing the arm onto the pulling lever).

Slacken more turnbuckles and even cable clamps **if wires are too tensed** (should not happen if anchors are well aligned and at the same level)

Once the turbine is closer to the ground, adjust the saw horse position taking care that the blades neither touch the ground nor the saw horse.

When you can reach the turbine, 2 people take the tail **carefully** and orientate it **so that the blades are facing upwards** and avoid to turn over. Place the tail in furling position and lean it against a support like a wooden palette to keep the turbine stable.

If you have to leave the tower down for a long time,
don't leave the grip hoist in the rain or snow.
Take down the gin pole, and remove the grip hoist temporary.



Fig. 16: Turbine lowered

5.3 Dismount the wind turbine

According to the maintenance level, you will not need to remove the alternator, but just the blades. In this case, skip the part “Removing the alternator & frame” and go directly in the next section “5.4 Reinstalling the turbine”, “Reinstalling the blades”.

Removing the blades

Before removing the blades, **make sure there is a mark to locate the position** of the rotor blades towards the alternator and a threaded rod.

If not, make a mark on a threaded rod and on the triangle that supports the blades (figure 17)

Remove the nuts and washers and take the blades off slowly by pushing it at the root of each blade at the same time. Put it in a safe place, where nobody can damage it.

If you need to dismount the blades, **be sure** there are **some marks** on each blade and on each maintaining piece (disk and triangle) to locate their position (figure 18), **before** disassembling them. **If not, make these marks.**



Fig. 17: Mark on a threaded rod and triangle



Fig. 18: Marks on blades and triangle

Removing the alternator & frame

First, remove the tail from its hinge while someone holds the alternator. If there is a loose washer on the top of the tower, remove it.

Disconnect **the 3-phase cable** into the junction box and remove the alternator and frame from the tower top hinge.

Be careful that the 3-phase cable does not slip down inside the tower, **hold it!**
Make a knot with the cable or fix something to the cable.

For testing and inspection see section 6.2 Alternator and frame.

5.4 Reinstalling the turbine

Reinstalling the alternator & frame

Insert the washer (if it is apart of the tower stub) on the top of the tower and apply some grease on it and on the tower stub.

Fasten an iron wire at the extremity of the 3-phase cable coming from the tower and insert the cable with the iron wire inside the yaw pipe of the frame.

Connect the 3-phase cables in the junction box, if necessary put **new terminal blocks** and fasten the cables to the frame with cable ties.

Put some grease on the tail hinge.

Insert the tail onto the hinge in furling position **while 1 or 2 persons push the alternator** to orientate the studs towards the sky. Place the tail against its support (see figure 20 below).



Fig. 19: Installing the alternator & frame



Fig. 20: Installing the tail

Reinstalling the blades

Be sure that alternator and tail are stable before mounting the blades

Check for the marked threaded rod, place and insert the blades prudently.

Put the washers and nuts.

Before tightening, check the position of the blades towards the tower: put each blade (one by one) parallel to the tower to check the distance between the blade tip and the tower. Repeat the operation for each blade to get the same distance everywhere.



Fig. 21: Installing the blades

Adjust the clamp of each nut to set the gap between each tip blade and the tower (tighten the nut of a blade more if it is too far from the tower)

Screw and tighten the lock-nuts and eventually apply threadlock for each nut.

5.5 Raise the tower

Everybody goes back to each anchor as described above in 5.2 Lower the wind turbine.
At least 2 people staying close to the turbine.
Make sure the **strap is still in position** on the top guy wire in lowering direction.

Place the arm on the pulling lever of the grip hoist and start to activate the lever slowly, while holding the tail and the blades (figure 22) because they will try to open abruptly and they can touch the ground (and be damaged).

Don't stay below the tower !



Fig. 22: Holding tail and blades



Fig. 23: Grip hoist to raise the tower

Once the tower is almost in vertical position, pull on the lowering direction top guy wire with the fastened strap (see figure 14). That avoids the tower making an abrupt motion to drop into the vertical position because the weight of the gin pole is pulling the tower backwards.

At the end of the operation, check the vertical position of the tower with a level in all 4 directions, and also by eye for upper parts of the tower (see figures 24 & 25).

Check the tension of all guy wires and adjust them. Tighten the turnbuckles and/or adjust the cable clamp positions.



Fig. 24 : Verticality check at the bottom of the tower



Fig. 25 : Verticality check of the upper parts of the tower

Before removing the grip hoist,
the gin pole should be fastened to the anchor point.

Fasten the turnbuckle linked to a chain or a piece of a guy wire to the lift anchor.

Once the gin pole is fastened securely, remove the grip hoist (hook, shackles, etc.) and the lateral cords.

Check that all guy wires and all fastenings like cable clamps, turnbuckles and shackles are well tightened and secured.

Secure the turnbuckles with a guy wire or a piece of an iron wire (see figure 13).

Finally unleash the turbine (switch OFF the brake).

6. Maintaining your wind turbine system

6.1 Blades

Wooden blades

Despite the fact that wood is a very good material for the blades, it needs some care because the tip is running at around 200 km/h.

Inspect the general condition of the blades. Look for cracks, holes and other damages. Take special care of the leading edge. If the leading edge is damaged you can fix it using epoxy resin. You can reinforce it using blade tape. Even though blade tape is expensive it gives very good results.

If you observe severe crack in the direction of the wood fibre, you might need to replace the blade.

It is very important to put a new layer of blade surface protection (linseed oil, polyurethane, etc.) each time you do a maintenance. Especially if you used linseed oil: It is better to warm the linseed oil and to apply as many layers as possible. Another less ecological but efficient option is to use varnish, polyurethane works very well and lasts quite long.

Remember to sand the surface of the blade lightly with (using a rough sand paper) before applying any product.

In order to facilitate the maintenance you can paint your blades with 2 different colours. Once the top paint is removed you will see the colour underneath indicating that it is time for a maintenance.

Check that the balancing weights are well fixed.

Fibreglass blades

Inspect for cracks within the resin of the surface. Fix them with a proper product if you see any cracks. Otherwise the water can get inside and damage the whole blade.

It is also recommended to clean the blades regularly (window cleaner was found to work very well for that purpose).

Plywood parts

Poor quality plywood does not seem to last very long on humid, sandy or salty external conditions.

If the plywood loses one or two layers (figure 26): take out the layer and apply the same product as used for the blades.

Change the plywood if it is badly damaged.

An option could be using a metal piece made from stainless steel or aluminium instead of plywood.

You can use larger washers or one big “washer” (figure 27) for the 3.6m and 4.2m turbine diameter, especially in a gusty and turbulent installation site.

For the vane plywood, see “Frame and tail” in section in “6.2 Alternator and Frame”.



Fig. 26: Damaged plywood

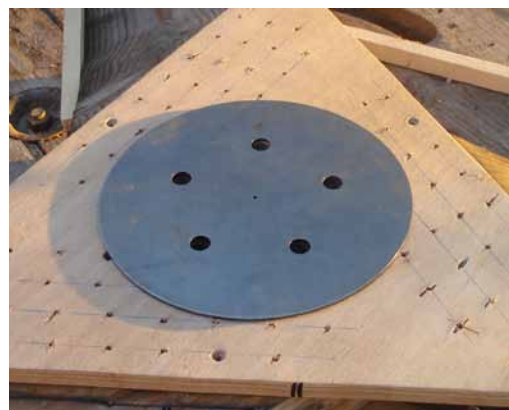

Fig. 27: Big washer

Blade balancing

Check the blade balancing while the turbine is spinning. If the tail vane is having quick left and right movements, your blade might need a new balancing.

If there is no wind you can also check the balance of the blades with the tower lying on its trestle.

Take special care with the screwing of the balancing weight. Use a sufficient number of screws (at least 2) and that are long enough (but should not touch the screws between plywood disk and triangle parts and the blades), otherwise the balancing weights might be thrown off. Use stainless screws.

If you forgot how to do the blade balancing, have a look into your construction manual.

6.2 Alternator and frame

Alternator disassembly

This action should be performed if you encounter one of these 2 problems:

- a) Failure of the bearings or
- b) Friction between rotor and stator.

It should also be done every 3 years.

You will need the 3 jacking screws for this operation.

Never put your fingers between the rotor disks, as they can be pinched!



Fig. 28: Alternator disassembly



Fig. 29: Index threaded rod and hole

The overall procedure operation is to take off the front rotor, then the stator and finally the back rotor but before processing **find the index hole (figure 29) or the mark on the stud which indicates alignment for reassembling.**

If you can't find it, make a new one on the stud and the two rotors (before disassembling).

Remember that it is very important to **have this position marked.**

Unscrew the nuts from the front rotor.

Screw the 3 jacking screws that go into the tapered hole. Screw them simultaneously to keep both rotors parallel all the time.

The rotors should be at equal distance all the time.

When you have reached 10cm, the magnet field is weak enough for you to pull the rotor away.

Store it in clean, dry place, away from metal components.

Take away the stator. Remember the stator position (it should be the cable at the bottom).



Fig. 30: Front rotor with the 3 jacking screws



Fig. 31: Friction on the stator

If you detect significant play in the hub, open everything to check and clean or change the roller bearing (see the procedure next page).

If the hub shaft is not welded, unscrew the nuts behind the bearing hub rotor of each stud and remove all the studs from the back rotor.

Remove the back rotor carefully and put it in a safe place, **far from the other rotor**.

Check the stator and rotor for cracks in the resin structure, for friction and for wires with missing enamel. You will need to change magnets if they are corroded (figure 32). Cut the resin and replace the corroded one with a new magnet. Refill the replaced material with new resin and repaint the whole rotor. Sometimes resin cracks occur at the edge of the rotor (figure 33). Take away the old resin that comes up and replace by a new one. Repaint the whole rotor.



Fig. 32: Damaged rotor



Fig. 33: Cracks in resin in the rotor edge



Fig. 34: Stator that needs to be changed

If any of the copper wires is without enamel, you should apply some resin or a bit of glue (like epoxy adhesive). You also need to find the cause of the problem and fix it (see Troubleshooting on page 40).

Check that you have the same resistance value between the phases by using a multimeter.

Check the 3-phase cable that comes out of the resin.

Replacing the roller bearings

Bearings need to be replaced if the rotor rubs against the stator or when the turbine no longer turns. They should be repacked with grease every 3 years or more frequently if necessary.

Usually you will require two different sets of roller bearings:

- 1) The basic kit (figure 34) with the two inner cones and the two roller bearings.
- 2) The full kit (figure 35) with the basic kit plus the rubber sealing, the nuts, the washer, the safety pin (sometimes optional) and the cap (sometimes optional).



Fig. 34: Bearings basic kit



Fig. 35: Bearings full kit

Remember: You have to change both roller bearings at the same time.

We recommend to get the full kit as it's good to have spare parts like a safety pin and it's hard to get rid of the rubber sealing without damaging it. Use quality brands like SKF or SNR if possible.

Make sure that your working space and your hands are clean of dust when you replace the bearings.

You can keep the shaft screwed on the nacelle during the whole operation.



Fig. 36: Exploded view of a whole bearing

Take out the cap by gently knocking it out with a chisel.

Depending on your hub: take off the safety pin and the nuts or strike out the nuts with a suitable drift.

Be careful with the nuts as you may encounter left hand thread or right hand thread!

Take away the flange and remove the rubber seal using a screwdriver (figure 37). If you do it gently you may be able to re-use the rubber seal.

Take out the outer shell by knocking it gently with a suitable drift. Keep it straight by tapping evenly on opposite sides and take care not to scratch the seating (figure 38). If you should damage the seating you can sand it with a 400 sand paper.



Fig. 37: Remove the seal



Fig. 38: Take out the outer shell

It can be tricky to press the new bearing shell into it's seating. The easiest thing is to use the old shell: Cut through with an angle grinder to make it less rigid (figure 39) and use it as a drift to put the new shell home. Use a hammer large enough or a hammer plus a socket to make sure that the pressure is well divided all around the shell (figure 40). You can also use a vice to keep stable the shell while knocking.



Fig. 39: Cut the shell with an angle grinder



Fig. 41: Lock the nut



Fig. 40: Put the new shell home

Don't mix up the sense of the shell!

Grease the bearings thoroughly, with bearing grease but do not jam them full of grease.

Start by putting the rear bearing on the shell, then assemble the rubber seal. Put it on the shaft and then fit the second bearing followed by a washer and a nut. Tighten the nut, spin the hub and then slack it off a quarter turn or so to reduce stress on the bearing.

Depending on the kind of hub:

- Use the safety nut and safety pin
- Lock the nut by striking it on both sides with a burin (see figure 41).

Add some grease in the cap and put it back gently.

You can find a video animation on "how to open and change the bearing" on the following website:

<http://www.tripalium.org/blog/default/post/id/330-nouvelle-video-danimation>

Note: some people experienced problems with freedom in the conical bearing especially with 4.2m diameter turbines. The problems occur after few years when the rotor rubs the stator. Better to use "NE" bearing that that comes with 2 deep groove bearings. We use "Knott" vehicle bearing houses.

Alternator assembly

Conduct the disassembly procedure in reverse. Take lots of care while approaching the magnet rotor. Magnets must face each other. Use the index hole to find the correct position.

Assemble everything and tighten well all nuts.

Unscrew the jacking screws at the same time until you can pull them out freely.

Apply thread lock to all stator studs and at the back of the hub. A drop of thread lock is enough.

Check the gap between the rotors and the stator. The gap between a rotor and the stator should be around 2 or 3mm. Remember that the most important thing is the voltage at 60rpm (see table 6).

You can adjust the gap by adding or removing nuts and washers.

Check the voltage at 60rpm.

Tab. 6: Voltage at 60 rpm

Ø Turbine	1.2m	1.8m	2.4m	3m	3.6m	4.2m
12V	1.9	2.3	2.9	3.5	4.2	5.2
24V	3.4	4.2	5.3	6.5	7.7	9.4
48V	6.8	8.4	10.6	12.9	15.6	18.8
350V	-	-	-	41.6	62.6	52.2

Electrical connection

Check the waterproofness of the junction box in the holes where the cables come in and out. If it is not waterproof, change the junction box, but **lower the tower before disconnecting the cables** inside this junction box ! The cables should come in and out at the bottom of the junction box, that reduce risk that rain comes into it.

Check the tightness of the terminal blocks and make sure that it has the correct tightness. This can save your turbine: We have already seen a wind turbine that was saved, hanging only by the terminal blocks (figure 42).



Fig. 42: Fall avoid by tight terminal block



Fig. 43: Reinforced tail

Frame and tail

Check the metal-frame for rust and cracks in the welds. Check all the other moving parts (tail hinge pipe) and if necessary, add some new grease. Check the condition of the washer inside the bearing and if necessary, replace it. If the washer is missing, add one. We recommend to have one welded washer and one loose for both tower and tail hinge pipes.

Sometimes the tail and tower hinge pipe are wear down (less than 1mm thickness), usually because a thin diameter pipe has been used (2 or 3mm). So you will need to replace them by a thicker pipe (4 or 5mm)

Check for cracks in the welding of the frame and tail vane (figure 44 displays a crack in the yaw pipe due to low end stop on a very turbulent site - the 3,6m turbine was only 2 years-old).



Fig. 44: Crack in the tail pipe

If necessary, reinforce the structure (figure 43).

Check the tightness of all the nuts on the tail vane.

Note: An unexpected low production can be due to a light tail vane. You can check the surface and thickness of the plywood wind vane and add some weight on the tail vane.

If you notice wooden tail cracks at the end of the brackets, you can extend the tail boom to the middle or end of the tail plywood and change the 2 diagonal brackets by 2 vertical ones (figure 45).



Fig. 45: Tail brackets

6.3 Tower and foundation

Tower



Fig. 46: Secured shackle



Fig. 47: Rusty guy wire



Fig. 48: Inhabitants in a junction box

Once the tower is down have a general look at the tower looking for rust, missing bolts, cracks in welding. Take special care at the tower yaw pipe, it's the one that are subject to the highest wear.

Check all the bolts on the tower, mast base and gin pole axes, turnbuckles and shackles. Don't forget to add thread-lock while tightening.

Check if the cable thimbles are in their correct position.

Check if all cable clamps are well tightened. If they start to rust you can protect them with grease.

Check if all shackles are secured (figure 46).

Check if all turnbuckles are secure and if bolts are well tightened.

Check the general condition of the guy wires. If you see some rust even severe rust (figure 47) you can protect the cables by soaking them in used motor oil. Use some fuel if the oil needs diluting.

If there is broken cable strand, you need to change the cable.

Remember that high quality galvanised, even more stainless, guy wires and fastenings last longer, even in harsh conditions.

Check the general condition of the cables at the bottom of the tower. It is a wearing part that needs to be changed from time to time, depending on your installation site and on the cable quality. Untwist the electrical cable at the bottom of the tower.

Make sure that the cable is free to twist at the bottom of the tower by removing the obstructing material (earth, sand, etc.).

Check the waterproofing of the junction box, or plug state at the bottom of the tower. Check that the electrical terminals are not too oxidised. Get rid of the inhabitants of the junction box if there are any (see figure 48).

Foundation

In case you have concrete foundations:

- check for cracks in the concrete,
- check the state of the rebar/chain that comes out of the concrete as it is exposed to weather and wear,
- clean the base of the tower, especially if it is sandy.

If you used a chain attached to heavy anchors buried under ground, dig a little bit to check the chain state. Even high quality galvanised chain rust in the ground (figure 49). Change the chain if it is rusted.

If you have big pile dig into the ground, check that the pile is not moving in direction on the tower and upward. If you have to tight the guy wires often it can be a proof of a moving pile.

If the pile is moving too much, you can secure it with a second one (figure 50) and check on a regular basis how the situation evolves.



Fig. 49: Weak chain



Fig. 50: Secured anchor

6.4 Electrical system

Inspection when the turbine is running

There is a risk of high voltage and high current during this testing procedure. Be careful.

The following recommendation are for off-grid and grid-tied systems

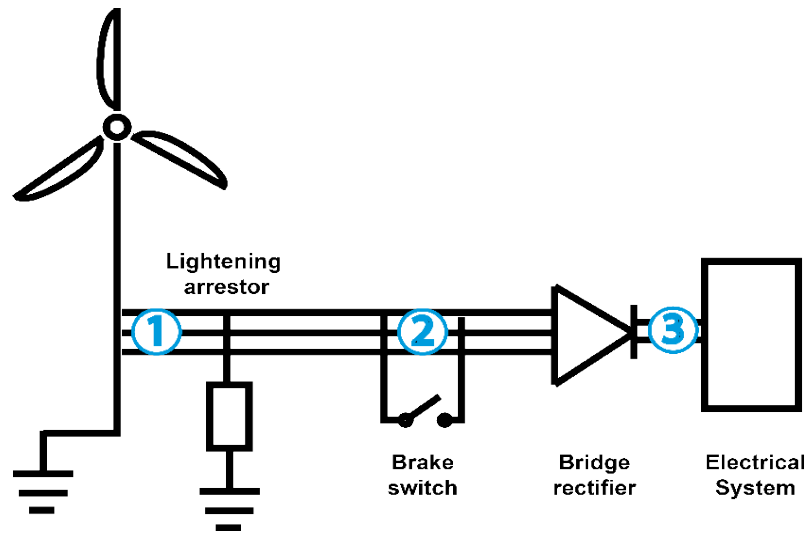

Fig. 51: Electrical scheme

To identify an electrical problem, check the voltage between the phases at the bottom of the tower (1 in figure 51), at the brake switch (2 in figure 51), and on the DC bus after the bridge rectifier (3 in figure 51).

If the voltage between 2 phases is zero, suspect a short-circuit in the wiring or in the alternator. A pulsating torque holding back the blades indicates a short between two of the 3 wires.

If case of a short-circuit, an easy test is to disconnect the tower wire. If the turbine still does not start, then the short is above: in the tower cable or in the alternator. If the turbine does start, then the short is elsewhere (wiring, rectifier or controller).

If no current is found, several possibilities:

There may be a short-circuit failure of the alternator windings due to burned coil or insulation failures in wet conditions: In this case lower the turbine to check the stator voltage output.

Electrical issues can certainly impact energy production. A blown diode in the rectifier or a bad connection in one wire will also have impact on the performance. These faults produce a growling vibration in the machine and uneven voltages and currents in the 3 wires.

- **Off-grid**

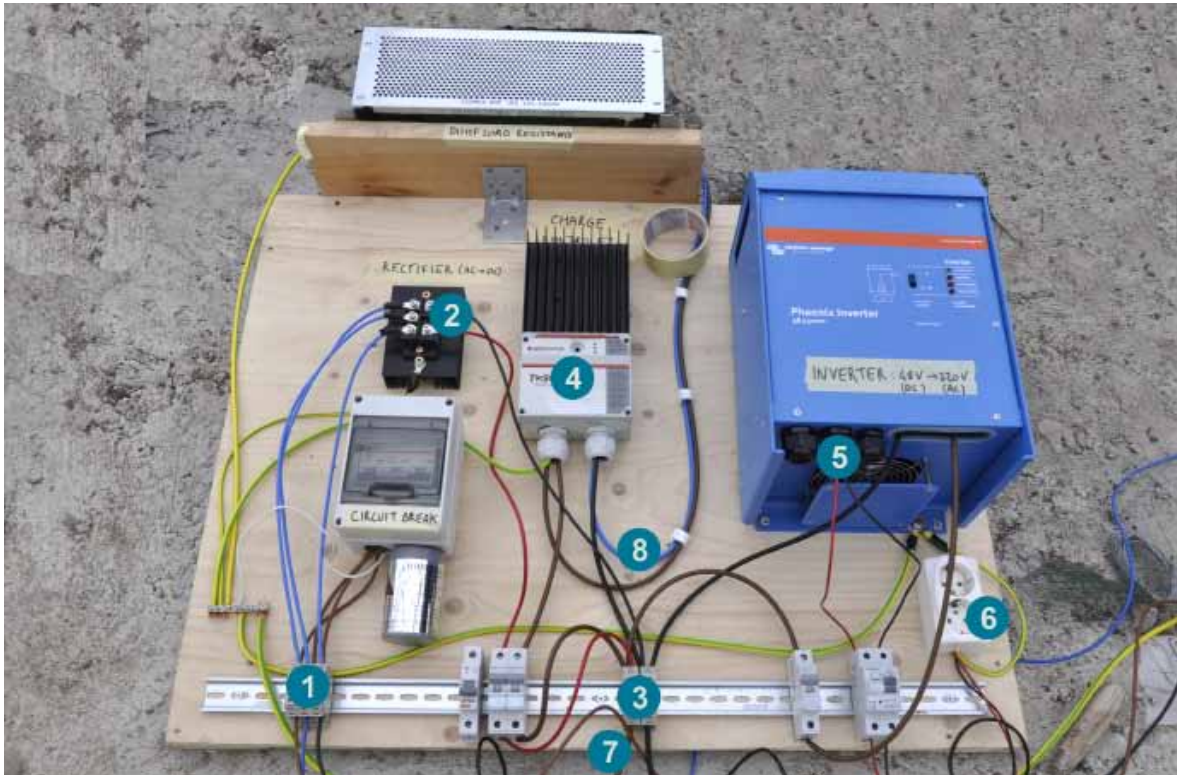

Fig. 52: Off-grid electrical panel

Explanation of figure 52:

Check the AC-voltage between each phase, it should be the same between each phases (1).

Check that the bridge rectifier is working properly by measuring the DC-voltage in (2). Also check the DC-voltage in different points of the circuit: Batteries (3), charge controller (4), inverter (5). It should be the same value.

Check the AC-voltage output on the inverter (6).

If you have a clamp meter check if there is current going into the batteries (7) and/or into the dump-load (8).

If your system has a meter, check if the values are in the same range. If you see some significant difference you might need to reset your meter (see procedure in your meter manual).

Check if the LEDs or the screen are working on the charge controller.

Stalling can occur if the battery voltage falls to below half of its nominal value due to heavy battery discharge or because of a failure. The turbine will be loaded with current at low speed and the blades will stall, preventing the turbine from reaching operating speed.

- Grid-tied



Fig. 53: Grid-tied panel

Explanation of figure 53:

Check the 3-phase voltage input from the wind turbine (1).

Check the voltage and the current of the DC bus (2) going to the inverter or the dumpload (3), using the inverter screen or a clamp meter.

Check that the inverter disconnection from the grid is working properly by turning off the grid (4). If the wind is strong enough, the tension will rise above the overvoltage protection limit and all the current goes to the dumpload (3).

Check the daily, monthly and/or annually yield on the inverter screen. Check if the values are correct (compare annual yield to average wind speed) (5).

Check error messages on the inverter (5).

Check that LEDs or screen are working on the charge controller.

Inspection when the turbine is short-circuited

The following recommendations are for both off-grid and grid-tied systems:

At this stage you may have to lower the turbine to do further investigations.

Switch ON the wind turbine (see figure 8 on page 12).

Remove the dust from all electrical components (fan, heatsink, dumpload) as it can disturb a proper cooling.

Check all the connections. Tighten them if necessary. Not well tightened wires can cause a fire and increase the risk of an electrical shock.

Check that all ground and metal parts (charge controller, dumpload, etc.) are connected to the same ground using a multimeter on continuity. You should have a bip or OL or small ohm value (figure 54).



Fig. 54: Multimeter on continuity position



Fig. 55: Diode testing

Check the diodes assumed your multimeter is equipped with the diode testing position (figure 55):

- Good diodes:
 - Forward diode : 0,2 to 0,8V
 - Reverse bias: OL
- Opened (bad) diode: OL in both way
- Shorted diode: 0 to 0,4V drop in both directions.

If your multimeter is not equipped with the diode testing position you can use a multimeter set to the Resistance mode (Ω).

The forward-biased resistance of a good diode should range from 1000Ω to $10M\Omega$.

The reverse-biased resistance of a good diode displays OL on a multimeter. The diode is bad if values are the same in both directions.

- **Off-grid**

Check the battery bank voltage and the voltage of each single battery.

For flood lead acid batteries: Check the level of distilled water by opening the cap. The lead plate should be flooded entirely. Add distilled water if necessary.

Check the battery bank connectors. Oxidised ones should be cleaned with sand paper and be protected with some grease (figure 56).

Check the fuses with your multimeter on continuity position (see figure 54).

Check the surrounding area of the dumpload and look for signs of overheating or burning. Make also sure the temperature in this area is neither too high nor too low. Humidity should be avoided as well.

If you need to change a cable or a connector, disconnect the system from the battery bank by switching the fuse or by removing the battery connector.

















Fig. 56: Grease on connectors

- **Grid-tied**

Check the surrounding area of the dumpload and the inverter, look for signs of overheating or burning.

7. Service frequency

Tab. 7: Service frequency

Frequency	Operations	Time commitment	Method (visual/tool...)
During the 1 st year	During the 1 st month	30 minutes	  
After 6 months		0,5 to 1 day	  
After 1 year		1 day	
Monthly	<p>See section 5. Lowering and raising the turbine and check all parts of the turbine for wear and corrosion</p> <p>Check all parts while the turbine is operating:</p> <ul style="list-style-type: none"> - Electrical system (battery voltage or inverter data) - Tension of the guy wires (tightness and rust of the fastenings) - Foundation, base and anchors of the tower - Visual and acoustical check on the turbine (missing nuts, abnormal spinning and/or vibration, etc.) 	30 min	  
Yearly (birthday)		1 to 2 days	
			    
Every 3 years	<ul style="list-style-type: none"> - Same as "yearly service" + dismount the alternator and bearings completely - Paint metal parts and add a new blade coating 	2 days	
After 9 years	<ul style="list-style-type: none"> - Same as "Every 3 years" + probability to change the inverter, the batteries: Change the blades and the guy wires if necessary 	3 days	

8. Check list



Sensory check-up
(optical, acoustical)







Tool check or operation with tool







Multimeter check

Inspection while the turbine is spinning:



Inspection should be done with a wind speed below 7m/s.

<p>Check if there is any strange noise and/or vibration while the SWT is spinning.</p> <p>Check if the electrical system is working normally.</p>	 
<p>Brake the turbine with the brake switch.</p> <p>For grid-tied systems: Disconnect the grid.</p>	
<p>Inspect each of the anchor points. Ensure that all equipment is secure and the guy wires are properly tensioned. Check to ensure that no strands are broken and the turnbuckle safety cables are in place. Check the state of the anchor point materials (concrete, chain, etc.)</p>	
<p>Install the grip hoist and the gin pole.</p> <p>Lower the turbine and continue with the checklist displayed on the following pages.</p>	



8.1 Wind turbine

<p>Inspect the blades for:</p> <ul style="list-style-type: none"> • Cracks noticeable in the wood or in the fiberglass (for resin blade), especially at the blade roots • Leading or trailing edge damage • Condition of the paint (if painted) or coating • Check if balancing weights are still fixed <p>Check the rotor and stator for scratches and failures in resin</p> <p>Inspect the metal frame for cracks and rust on the welding</p> <p>Inspect the condition of the electrical cable and the gripping system</p> <p>Check for cracks or loose equipment on the tail-boom and vane</p>	
<p>Check the tightness on the blade nuts</p> <p>Check the front bearing for seal integrity and grease loss. Check the thightness of the flange</p> <p>Check the play in the hub</p> <p>Check the connections in the junction box and the junction box condition</p>	
<p>Check the tail pivot system, it should move freely and have enough grease</p> <p>Release the turbine switching the brake OFF and check that the generator turns freely</p>	
<p>Measure the resistance between each phase</p>	

8.2 Tower and guy wires

Check if the electrical cable is twisted and check the condition of the cable.	
Check the tower weldings.	
Check the tightness of the cable clamps.	
Make sure that the tower shackles are secure and/or well tightened.	
Check the tightness of the fasteners (tower and base).	
Check the connection at all ground rods, at the tower and guy wires.	
Check the connections in the junction box and the condition of the junction box.	

8.3 Electrical system

Make a visual inspection for evidence of heat.	
Check if there are rusted parts (screws, crimp lugs, etc.).	
Remove the dust from all electrical components.	
Check the tightening of the electrical connections	
Check the bridge rectifier	
Check all the ground connections	

Only relevant for off-grid systems:

Check the general state of the batteries and the water level, refill distilled water if necessary.	
Check the tightening of the electrical connections.	

Only relevant for grid-tied systems:

Check the production on the inverter and see if the values are relevant: <ul style="list-style-type: none"> • Is electricity generation linked to the estimated wind conditions at the installation site? • Is the data well recorded? 	
--	---

9. Troubleshooting

The following table is a non-exhaustive enumeration of damages and problems that might occur:

Tab. 8: Troubleshooting

Observation	Diagnosis / causes	Problem	Remedies
Blades are not spinning	Hub bearing is stuck	Lack of grease	Add some grease inside the bearing
		Water ingress in hub bearing	Replace the corroded parts and the bearing seal
		Nut too tight	Loosen the nut
		Roller bearing out of order	Change the roller bearing
	Ice in generator		Wait for warm weather
	Ice on blade		Wait for warmer temperatures/ make the surface blade smoother
		Batteries below their voltage value	Charge the batteries, you may have to change them
The brake switch is ON		Switch the brake OFF	
Blades are spinning slowly in strong wind	Stator and rotor are touching (scraping or rubbing sound at low rpm)		Increase spacing between stator/rotor (use Loctite 243 on threads afterwards)
		Magnet swelling due to corrosion	Change the affected magnet
		Damaged roller bearing	Change the roller bearing
		Unscrewed or missing nuts on the stator studs	Tighten them with threadlock
	Debris between rotor and stator		Turn propeller gently by hand and blow, use piece of plastic or some tape to dislodge debris
	Short circuit	Power cable is pinched at the top or bottom of the tower	Clear the top/bottom of the tower
		Burnt out stator	Build a new one
		Burnt out bridge rectifier	Find the problem and change the rectifier
		The brake switch is ON	Switch the brake OFF
		Burnt out inverter (grid connected)	Find the problem and change the inverter
		Burnt out charge controller	Find the problem and change the charge controller
	Burnt out stator	Incorrectly calibrated furling system (tail too heavy or too long)	Correct the weight problem
	Burnt out charge controller	All the energy goes into the dumpload. That can suck out your batteries	Find the problem and change the charge controller
		Wrong cable connection (e.g. wrong connection in power cable)	Correct the connection

Tab. 8: Troubleshooting

Observation	Diagnosis / causes	Problem	Remedies	
Blade runs too fast, may whistle	Load disconnected	Cable disconnected or wrong connection	Check all the electrical connections and fuses	
		Disconnected dumpload	Re-connect the dumpload	
		Burnt out bridge rectifier	Find the problem and replace the rectifier	
		Burnt out voltage regulator	Find the problem and replace the voltage regulator	
	Generator problem			Problem will be "solved" once the voltage reaches the regulator voltage
				Be sure that magnets are facing each other Reduce the gap between rotor and stator
	Dumpload	Dumpload wrong scaled	Change the dumpload	
Battery bank	Battery bank too small	Increase the capacity of the battery bank		
Broken blade	Tail vane hit the blade	Poor welding of high end and/or low end stop	Redo the welding and/or add some metal pieces to reinforce the tail vane	
		Unbalanced blade causing excessive vibration (tail vane jumps off)	Balance the blade / check the balance weight screw	
	Losing a balancing weight	Wrong number, length or poor quality of the screw/s used to attach the balancing weight/s	Correct the default	
	Low quality or excessively thin wood		Use a better quality/thicker wood	
Tail, generator and tower shake at all or some wind speeds	Blade out of balance		Rebalance the blades	
	Guy wire too loose	Check the guy wire tension	Increase the tension, change or add turnbuckles	
		Check for default in the anchors	Redo the anchors/ add some weight	
Tail vane on the ground	Blade out of balance		Rebalance the blades	
	Failure of a tail welding		Reinforce the tail vane and rebalance the blade	
Excessive noise (whispering noise)	Trailing edge too thick		Re-shape the trailing edge	
	Hole in the blade		Fix it with resin or something equivalent	
	Blades not in the same plan		Correct planarity of the blades	

Tab. 8: Troubleshooting

Observation	Diagnosis / causes	problem	remedies
Excessive noise (vibrating noise)	Damaged bearing		Replace the roller bearing
	Generator roaming	Happened on high voltage generator due to copper wire vibration	Make sure your coils are well wound. Change the number of phases in a new stator (6 at least), use an active rectifier
	Blade(s) out of balance		Rebalance the blade(s)
Batteries not charging	Dump load constantly activated	Burnt out voltage regulator (possible due to lightning strike)	Find the problem and change the voltage regulator
		Batteries are full, not enough consumption	Invite some friends to your home
	Batteries reach end of life		Replace the batteries
	Excessive domestic power consumption		Reduce your demand or add some more energy production to the system
No power feed-in to the grid	Electrical connection		Check the phase, neutral and ground connection between inverter and grid
		Cable disconnected	Re-connect the cable
	Grid disconnected		Wait for the grid to come back
	Inverter monitoring the grid		Wait for the inverter to connect to the grid/and or the wind blow stronger
	Generator problem		See above "Blade runs too fast"
Low energy production	Electrical connection	Blown diode	Change the bridge rectifier
		Bad connection in one wire	Redo the connection or change the wire
	Furling system	Furls too early	Add some weight on the tail vane or change the wind vane
	Wind resource	Poor wind site	Increase the tower height

10. Logbook

Tab. 9 : Logbook

Wind turbine initial operation date:					
Date	Who	Type of maintenance (frequency, corrective...)	Problems / observations	Work done	Production (kWh)

10. Logbook

Tab. 9 : Logbook

Wind turbine initial operation date:					
Date	Who	Type of maintenance (frequency, corrective...)	Problem/observation	Work done	Production (kWh)

Appendix [Crash wall]



Fig. 57: Blown batteries



Fig. 58: Broken guy wires



Fig. 59: Broken bearing



Fig. 60: Broken anchor



Fig. 61: Broken tail hinge



Fig. 62: Burnt stator



Fig. 63: Burnt Tristar batteries



Fig. 64: Loss of balancing weight



Fig. 65: Rusted guy wire



Fig. 66: Rusted rotor



Fig. 67: Threaded rod too long



Fig. 68: Tower too tight

Appendix [Crash wall]

Blown batteries (figure 57): This is what happens when you use a grinder next to your battery bank while it's charging (sparks + hydrogen)

Broken guy wires (figure 58): A guy wire breaks...

Remedy: Use good quality guy wire or correctly sized guy wires. Chandlery correct tightness.

Broken bearing (figure 59): Bearing was loose and the rubber sealing was missing: Destruction of the bearing rolls, one rotor touched the stator, damages on both rotors and stator.

Remedy: Keep and/or add rubber sealing. Avoid play in the conical bearing or use NE bearing.

Broken anchor (figure 60): A 22 m/s wind finished to cut a chain holding the guy wires already eroded by sand and lead to the fall-down of the tower and the turbine. The pin at the tower base came off and couldn't avoid the tower fall-down. Everything was destroyed except rotors: blades, frame, tail, tower a bit deformed but re-used.

Remedy: Change guy wires and chains if wear is observed; pour chain into concrete. Change the tower base, the stator, the tail, the frame and replace the 3-phase cable.

Broken tail hinge (figure 61): On a very turbulent site, the tail was always moving up and down leading to cracks on the hinge at the low stop level.

Remedy: Reinforce the welding (see figure 43, page 28) if your turbine is installed on a very turbulent site.

Burnt stator (figure 62): Wind turbine short circuited for some time. A strong windy day leads to this failure.

Remedy: In case of strong wind, let your turbine run instead of braking it.

Burnt Tristar batteries (figure 63): Problem with a battery that lead the burning of the Tristar which then dumped the battery pack energy directly into the dumpload.

Remedy: Check your battery bank. Make sure that your charge controller capacity (e.g. if your system gives 40A, a 45A charge controller is undersized).

Loss of a balancing weight (figure 64): The turbine lost one balancing weight leading to severe blade unbalancing. The owner was away for few days during a windy period. The turbine might have shake for some days before falling off the tower.

Remedy: Use a greater number of screws that are long enough for the balancing weight, at least 2 per balancing weight and good quality screws (stainless).

Rusted guy wire (figure 65): After 6 months old in a sandy area of the African coast with brand new (quality) guy wires

Remedy: Car oil or plant oil to protect them from corrosion.

Rusted rotor (figure 66): During a preventative maintenance we have seen some cracks in the resin and a little space between the resin and the steel disc. As a consequence we could quite easily remove the block of resin from the disc. Under the resin, the disc was rusted.

Remedy: Paint the rotor during every maintenance. Paint or galvanise (best solution) the steel disk before putting the magnets.

Thread rod too long (figure 67): 28m tower; 4.2m turbine. On a very windy day, the tail vane hit the blade: blade and stator broken, frame and tail badly damaged. The thread rod was too long so the balancing weight touched the thread rod, breaking the stator and damaging the frame. A problem that could have been avoided by more precise work.

Remedy: We changed the design of the tail vane for the 4.2m turbine. Make sure you are checking all details especially on big turbines. The bigger they are, the more precise you have to be.

Tower too tight (figure 68): This curvy tower is the result of an excessive tension in the guy wires.

Remedy: Straighten the tower and slacken the guy wires.